

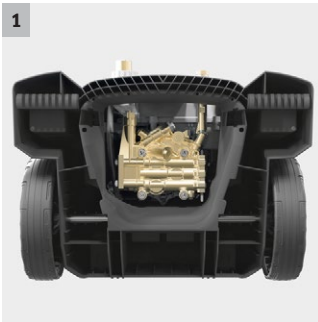

HD 6/15 M

AC-powered HD 6/15 M mobile high-pressure cleaner with 3-piston axial pump. Compact, reliable machine with high cleaning performance and energy efficiency for daily use.

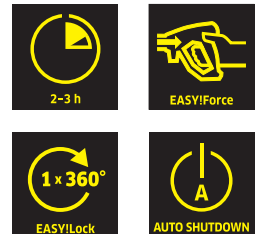

1 High-quality equipment

- Automatic pressure relief for protecting the components extends their life.
- Powerful, 2-pole, air-cooled electric motor.



2 Flexible operation

- For vertical and horizontal operation.
- Maximum stability during horizontal operation as the wheels do not touch the floor.

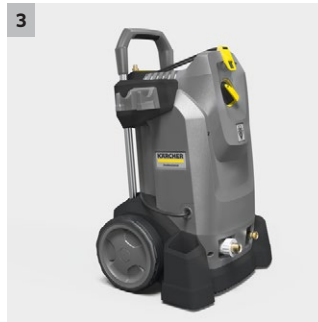

3 Outstanding mobility

- The push handle, which can be retracted at the touch of a button, increases the compactness of the machine and reduces the spatial requirement.
- Can be easily stored in service vehicles.



4 Clever accessory storage

- Holder for the cup foam lance.
- EASY!Lock TR20 permits storage of the Power nozzle or a surface cleaner directly at the machine.



HD 6/15 M

- 3-piston axial pump with hardened stainless steel pistons
- Save time and effort: EASY!Force high-pressure gun and EASY!Lock quick-release couplings.
- Automatic pressure relief and up to 20 percent higher energy efficiency

Technical data

Order no.	1.150-930.0	
EAN code	4054278233963	
Current type	Ph / V / Hz	1 / 230 / 50
Flow rate	l/h	560
Working pressure	bar / MPa	150 / 15
Max. pressure	bar / MPa	225 / 22.5
Max. inlet temperature	°C	60
Connection load	kW	3.1
Weight (with accessories)	kg	29
Dimensions (L × W × H)	mm	400 × 455 × 700
number of simultaneous users		1
Mobility		High

Equipment

Spray gun		EASY!Force
High-pressure hose	m	10 / Premium quality
Spray lance	mm	840
Power nozzle		■
ANTI!Twist		-
Pressure cut-off		■
Servo Control		-

■ Included in the scope of supply.

HD 6/15 M 1.150-930.0

KÄRCHER



	Order no.	ID	Max. working pressure	Length	Price	Description	
Standard with unions on both sides							
High-pressure hose 2 x EASY!Lock DN 8, 315 bar, 10 m, ANTI!Twist	1	6.110-031.0	315 bar	10 m		High-pressure hose (ID 8) suitable for up to 315 bar pressure. High-pressure hose with innovative EASY!Lock hand screw connection at both ends, ANTI!Twist, 10 m long.	▲
High-pressure hose 2 x EASY!Lock DN 8, 315 bar, 15 m, ANTI!Twist	2	6.110-030.0	315 bar	15 m		15 m long high-pressure hose, ID 8, with ANTI!Twist at both ends with time-saving EASY!Lock hand screw connection.	▲
High-pressure hose 2 x EASY!Lock DN 8, 315 bar, 20 m, ANTI!Twist	3	6.110-032.0	315 bar	20 m		High-pressure hose (ID 8), 20 m long, with time-saving and robust EASY!Lock hand screw connection at both ends. For up to 315 bar pressure.	▲
High-pressure hose, 2 x EASY!Lock, DN 8, 315 bar, 30 m, ANTI!Twist	4	6.110-014.0	315 bar	30 m		Convenient length (30 m) and innovative EASY!Lock hand screw connection: high-pressure hose (ID 8) with ANTI!Twist for up to 315 bar pressure.	▲
High-pressure hose, 2 x EASY!Lock, DN 10, 220 bar, 15 m	5	6.110-042.0	220 bar	15 m		With innovative EASY!Lock hand screw connection for up to 220 bar pressure: 15 m long high-pressure hose (ID 10).	▲
High-pressure hose, 2 x EASY!Lock, DN 10, 220 bar, 20 m	6	6.110-043.0	220 bar	20 m		Main features of this high-pressure hose (ID 10): 20 m long with extremely time-saving and convenient EASY!Lock hand screw connection at both ends.	▲
High-pressure hose, 2 x EASY!Lock, DN 10, 220 bar, 25 m	7	6.110-044.0	220 bar	25 m		Impressive values and basic equipment: high-pressure hose, (ID 10), 25 m long, for up to 220 bar pressure.	▲
High-pressure hose, 2 x EASY!Lock, DN 10, 220 bar, 40 m	8	6.110-045.0	220 bar	40 m		40 m long high-pressure hose with EASY!Lock system for time-saving hand screw connection (at both ends). (ID) 10, up to 220 bar working pressure.	▲
High-pressure hose, 2 x EASY!Lock, DN 12, 210 bar, 15 m	9	6.110-059.0	210 bar	15 m		Suitable for up to 250 bar working pressure: high-pressure hose (ID 12), 15 m long, with convenient EASY!Lock hand screw connection at both ends.	▲
High-pressure hose, 2 x EASY!Lock, DN 12, 210 bar, 40 m	10	6.110-060.0	210 bar	40 m		With EASY!Lock hand screw connection, 40 m long for wide working radius: high-pressure hose (ID 12) with EASY!Lock hand screw connection at both ends. Suitable for up to 250 bar working pressure.	▲
High-pressure hose, 2 x EASY!Lock, DN 10, 220 bar, 10 m	11	6.110-041.0	220 bar	10 m		Impressive values and basic equipment: high-pressure hose, (ID 10), 25 m long, for up to 220 bar pressure.	▲
High-pressure hose, 2 x EASY!Lock, DN 6, 250 bar, 10 m	12	6.110-034.0	250 bar	10 m		High-pressure hose, 10 m long with EASY!Lock hand screw connection at both ends. ID 6, suitable for up to 250 bar.	□
High-pressure hose 2 x EASY!Lock DN 6, 250 bar, 10 m, ANTI!Twist	13	6.110-035.0	250 bar	10 m		High-pressure hose with EASY!Lock hand screw connection at both ends (ID 6), 10 m long. Suitable for up to 250 bar pressure with ANTI!Twist.	□
High-pressure hose 2 x EASY!Lock DN 6, 300 bar, 10 m, ANTI!Twist	14	6.110-056.0	300 bar	10 m		High-pressure hose (ID 6) with ANTI!Twist and new EASY!Lock hand screw connection at both ends. For up to 300 bar pressure. 10 m long.	□
Longlife 400 with unions on both sides							
Longlife 400 high-pressure hose, 2 x EASY!Lock, DN 8, 400 bar, 10 m, ANTI!Twist	15	6.110-038.0	400 bar	10 m		Durable, 10 m long high-pressure hose (ID 8) with double steel reinforcement and EASY!Lock hand screw connection at both ends and ANTI!Twist. Approved for 400 bar pressure.	▲
Longlife 400 high-pressure hose, 2 x EASY!Lock, DN 8, 400 bar, 30 m, ANTI!Twist	16	6.110-023.0	400 bar	30 m		Durable high-pressure hose with double steel reinforcement, ANTI!Twist and EASY!Lock hand screw connection at both ends. ID 8, 30 m long, for up to 400 bar pressure.	▲
Longlife 400 high-pressure hose, 2 x EASY!Lock, DN 8, 400 bar, 20 m, ANTI!Twist	17	6.110-027.0	400 bar	20 m		High-pressure hose with ANTI!Twist, EASY!Lock hand screw connections and double steel reinforcement. 20 m long, ID 8, EASY!Lock hand screw connection at both ends.	▲
Longlife 400 high-pressure hose, 2 x EASY!Lock, DN 8, 400 bar, 15 m, ANTI!Twist	18	6.110-029.0	400 bar	15 m		The double steel reinforcement ensures a long lifetime of this 15 m long high-pressure hose (ID 8), approved for up to 400 bar pressure hose.	▲

■ Included in the scope of supply. □ Available accessories. ▲ Extension hose.

HD 6/15 M 1.150-930.0

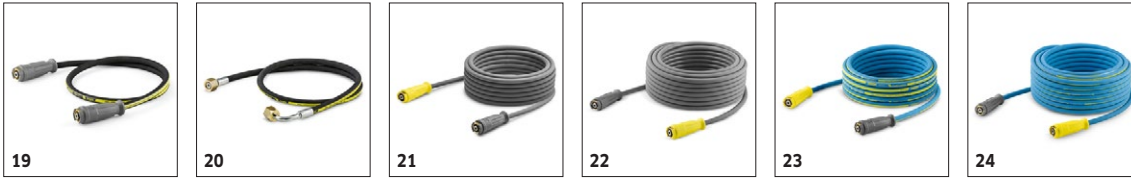

		Order no.	ID	Max. working pressure	Length	Price	Description	
Longlife 400 high-pressure hose, 2 x EASY!Lock, DN 8, 400 bar, 1.5 m	19	6.110-024.0	8	400 bar	1.5 m		1.5 m short high-pressure hose (ID 8). With convenient EASY!Lock hand screw connection at both ends for robust and fast connections. Durable, for up to 400 bar pressure.	<input type="checkbox"/>
Longlife 400 high-pressure hose, 1 x EASY!Lock, 1 x M22 x 1.5, DN 8, 400 bar, 1.5 m	20	6.110-069.0	8	400 bar	1.5 m		High-pressure hose (ID 8) with double steel reinforcement, 30 m long, suitable for up to 400 bar pressure. Connectors: M 22 x 1.5, quick and convenient EASY!Lock hand screw connection.	<input type="checkbox"/>
Food industry version with unions on both sides								
High-pressure hose, food grade, 2 x EASY!Lock, DN 8, 10 m, AN-TITwist	21	6.110-051.0	8	250 bar	10 m		High-pressure hose (ID 6), 10 m long, with grey, non-marking outer covering. Approved for use in the food industry. With quick and robust EASY!Lock hand screw connection at both ends.	<input type="checkbox"/>
High-pressure hose, food grade, 2 x EASY!Lock, DN 8, 20 m, AN-TITwist	22	6.110-052.0	8	250 bar	20 m		Suitable for use in food industry: 20 m long high-pressure hose (ID 8) with grey, non-marking outer covering, AN-TITwist and EASY!Lock hand screw connections.	<input type="checkbox"/>
Longlife food design with screw connections at both ends								
Longlife 400 high-pressure hose, food grade, 2 x EASY!Lock, DN 8, 10 m, AN-TITwist	23	6.110-053.0	8	400 bar	10 m		With blue, non-marking and animal fat resistant outer covering: durable high-pressure hose (ID 8), 10 m long, AN-TITwist and EASY!Lock hand screw connection at both ends.	<input type="checkbox"/>
Longlife 400 high-pressure hose, food grade, 2 x EASY!Lock, DN 8, 20 m, AN-TITwist	24	6.110-054.0	8	400 bar	20 m		Durable high-pressure hose with double steel reinforcement and blue, non-marking and animal fat resistant outer covering. 20 m long with EASY!Lock hand screw connections.	<input type="checkbox"/>

■ Included in the scope of supply. □ Available accessories. ▲ Extension hose.

HD 6/15 M 1.150-930.0

KÄRCHER

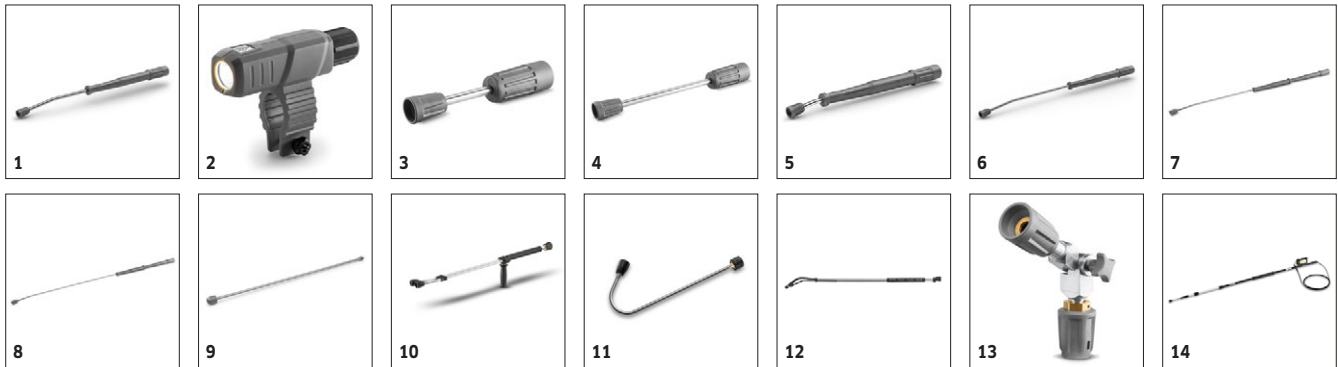

		Order no.	Max. working pressure	Length		Price	Description	
Rotating spray lances								
Spray lance, 840 mm, rotating	1	4.112-006.0	300 bar	840 mm			850 mm stainless steel lance (manual coupling) with ergonomic handle for ease of use and protection. Rotatable 360° under pressure.	■
LED nozzle light	2	2.680-002.0		125 mm			Bright, lightweight LED work light for direct mounting on spray lance of EASY!Force high-pressure gun. Better view in unfavourable lighting conditions for up to 5 working hours.	□
Spray lance, 250 mm, rotating	3	4.112-027.0	300 bar	250 mm			Spray lance, 600 mm, rotatable, ergonomic	□
Spray lance, 400 mm, rotatable	4	4.112-024.0	300 bar	400 mm				□
600 mm spray pipe, rotatable	5	4.112-007.0	300 bar	600 mm			600 mm stainless steel lance (manual coupling) with ergonomic handle for ease of use and protection. Rotatable 360° under pressure.	□
1050 mm spray pipe, rotatable	6	4.112-000.0	300 bar	1050 mm			1050 mm stainless steel lance (manual coupling) with ergonomic handle for ease of use and protection. Rotatable 360° under pressure.	□
1550 mm spray pipe, rotatable	7	4.112-018.0	300 bar	1550 mm			1550 mm stainless steel lance (manual coupling) with ergonomic handle for ease of use and protection. Rotatable 360° under pressure.	□
2050 mm spray pipe, rotatable	8	4.112-021.0	300 bar	2050 mm			2050 mm stainless steel lance (manual coupling) with ergonomic handle for ease of use and protection. Rotatable 360° under pressure.	□
EASY!Lock 1000 mm spray lance extender	9	4.112-048.0	300 bar	1000 mm			Spray lance extension with EASY!Lock connection. Length 1000 mm.	□
Double lance								
Double lance 960 mm	10	2.112-016.0	310 bar	960 mm			960 mm double lance for variable pressure adjustment on handle at full water flow rate. Suitable for agricultural use (e.g. stable cleaning).	□
Angular spray lance								
Spray lance for toilets and rain gutters	11	4.112-029.0					Stainless steel lance WC and gutter with nozzle insert. Specially shaped for effective and hygienic cleaning of gutters and toilets.	□
Flexible spray lance								
Flexible lance 1050 mm	12	4.112-035.0	210 bar	1050 mm			1050 mm flexible lance with variable bend from 20° to 140°, ideal for cleaning difficult to reach areas, e.g. gutters.	□
TR 20 articulated joint	13	4.112-057.0	300 bar				For hard-to-reach areas: High-pressure articulated joint with infinite angle adjustment up to 120°. Simply attach directly to the spray lance of the pressure washer.	□
Telescopic spray lance								
Telescopic spray lance	14	4.112-037.0	225 bar	5400 mm			Can be continuously extended from 1.8 to 5.4 m. For cleaning areas that are difficult to reach, such as ceilings or facades. With integrated HD trigger gun, M 22 x 1.5 connection with rotary coupling. Connection for M 18 x 1.5 nozzles.	□
Strap for telescopic spray pipe	15	6.373-987.0					Convenient strap for relief when working with the telescopic spray lance (6.394-690). The burden is optimally distributed on the body and longer periods of use are possible.	□
Gutter cleaner								
Gutter cleaning lance	16	2.112-015.0		960 mm			The lance is suited for cleaning of gutter systems. Because of the shape of the lance and the special nozzle the gutter can be cleaned without removing the cover plates.	□
Undercarriage spray lance								
Underbody lance	17	4.112-032.0		700 mm			Stainless steel lance for effective and easy underbody and wheel arch cleaning. Without high-pressure nozzle.	□

■ Included in the scope of supply. □ Available accessories. ▲ Extension hose.

HD 6/15 M

1.150-930.0



		Order no.	Max. working pressure	Length		Price	Description	
Additional handle								
Additional handle for EASY!Lock spray lances	18	4.321-380.0					Comfortable in every situation - the additional handle is easy to attach to the spray lance of our new EASY!Lock generation and makes work easier by allowing you to adjust your posture to suit the particular task. Regularly changing your posture relieves the strain on your body, making work more relaxed. Thanks to the 360°-rotatable spray lance, the additional handle can simply be fully rotated whilst working for greater flexibility.	<input type="checkbox"/>
PowerControl spray lance								
PowerControl spray lance 034	19	4.112-045.0					Infinitely variable pressure adjustment during operation directly in the operator's gripping area, especially for machines without servo control function. The cleaning performance can be adapted to the respective task in an instant. The low pressure mode for the application of the cleaning agent and the adjustment of the jet level round off the product.	<input type="checkbox"/>

■ Included in the scope of supply. □ Available accessories. ▲ Extension hose.

HD 6/15 M 1.150-930.0



1-4

		Order no.	Nozzle size				Price	Description	
Power nozzle spray angle 25°									
Power nozzle	1	2.113-063.0	33					Fan jet nozzle for large-area coverage and stubborn dirt and stains.	■
HP nozzle spray angle 0°									
Power nozzle	2	2.113-001.0	40					High-pressure nozzle with powerful jet for extremely stubborn dirt.	□
Power nozzle spray angle 15°									
Power nozzle	3	2.113-002.0	33					Flat jet nozzle for stubborn dirt.	□
Power nozzle spray angle 40°									
Power nozzle	4	2.113-003.0	40					Power nozzle with a 40° spray angle and fan jet, suitable for large areas and sensitive surfaces.	□

■ Included in the scope of supply. □ Available accessories. ▲ Extension hose.

HD 6/15 M

1.150-930.0

KÄRCHER

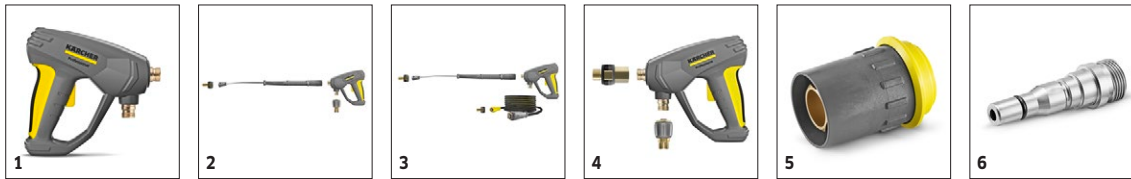

		Order no.	Flow rate					Price	Description	
Trigger guns										
EASY!Force Advanced	1	4.118-005.0							Effortless, not energy-sapping: the EASY!Force high-pressure gun uses the recoil force of the high-pressure jet to reduce the holding force for the operator to zero.	■
EASY!Force conversion kit 1 - from high-pressure hose	2	4.111-050.0							For retrofitting Kärcher high-pressure cleaners with existing high-pressure hose: EASY!Force conversion kit 1 with EASY!Force high-pressure gun, spray lance and all adapters through to the nozzle.	□
EASY!Force conversion kit 2 - from machine	3	4.111-051.0							Developed for retrofitting existing high-pressure cleaners from Kärcher: EASY!Force conversion kit 2 with EASY!Force high-pressure gun, spray lance, high-pressure hose and necessary adapters.	□
EASY!Force conversion kit 3 - high-pressure gun	4	4.111-052.0							Compatible with existing high-pressure hose and spray lance: EASY!Force conversion kit 3, incl. EASY!Force trigger gun and all necessary adapters for upgrading your high-pressure cleaner.	□
Quick connect										
Quick coupling	5	2.115-000.0							For fast changes between different spray lances/accessories. Perfect for Kärcher spray unit, suitable for trigger gun/spray lance interface. With M 22 x 1.5 internal thread.	□
Male coupling	6	2.115-001.0							Hardened stainless steel male coupling for quick coupling 2.115-000. With M 22 x 1.5 external thread.	□

■ Included in the scope of supply. □ Available accessories. ▲ Extension hose.

HD 6/15 M 1.150-930.0

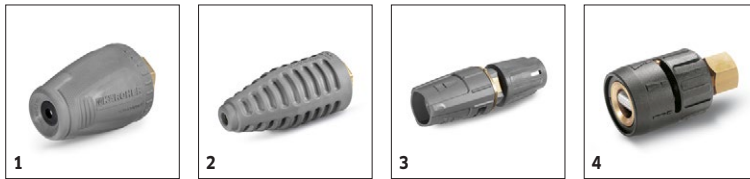

		Order no.	Max. working pressure	Nozzle size		Price	Description	
Dirt Blaster, small								
Dirt blaster	1	4.114-019.0	180 bar	35			The new performance dirt blaster (nozzle size 035) with rotating point jet makes a big difference: up to 50% higher cleaning and area performance than its predecessor.	<input type="checkbox"/>
Dirt blaster, large								
Dirt blaster	2	4.114-040.0	300 bar	35			The dirt blaster with rotating pencil jet offers 10 times better cleaning performance. Ceramic nozzle and bearing ring for a long service life. Further data: Max. 300 bar, 30 MPa, 85°C.	<input type="checkbox"/>
Triple nozzles								
Triple nozzle	3	4.117-028.0	300 bar	33			Triple nozzle with manual nozzle changeover. Convenient spray adjustment. For high-pressure cleaners with injector; low-pressure fan jet for detergent removal and application. Connector M 18x1.5.	<input type="checkbox"/>
Angled vario nozzle 0-90°								
Angled Vario nozzle	4	4.113-007.0		50			Variable angle nozzle for spray angle adjustment from 0° to 90°. For easy adjustment to all kinds of soiling and surfaces.	<input type="checkbox"/>

■ Included in the scope of supply. □ Available accessories. ▲ Extension hose.

HD 6/15 M 1.150-930.0



22

		Order no.					Price	Description	
Adapter 12 rotary coupling EASY!Lock 22 IG - M22 x 1.8 AG	22	4.111-046.0						Rotatable adapter for connecting EASY!Force high-pressure gun and high-pressure hoses with M 22x1.5 connection	<input type="checkbox"/>

■ Included in the scope of supply. □ Available accessories. ▲ Extension hose.

HD 6/15 M

1.150-930.0



		Order no.	Max. working pressure	Nozzle size	Diameter		Price	Description	
Pipe cleaning hose, ID 6									
Pipe cleaning hose, ID 6, 10 m, max. 250 bar	1	6.110-046.0	250 bar					The 10 m pipe cleaning hose is a highly flexible high pressure hose for pipe interior cleaning (threaded connection for nozzle R 1/8).	<input type="checkbox"/>
Pipe cleaning hose, ID 6, 20 m, max. 250 bar	2	6.110-008.0	250 bar					The 20 m pipe cleaning hose is a highly flexible high pressure hose for pipe interior cleaning (threaded connection for nozzle R 1/8).	<input type="checkbox"/>
Pipe cleaning hose, ID 6, 30 m, max. 250 bar	3	6.110-047.0	250 bar					The 30 m pipe cleaning hose is a highly flexible high pressure hose for pipe interior cleaning (threaded connection for nozzle R 1/8).	<input type="checkbox"/>
Pipe cleaning hose, ID 6, 10 m, max. 140 bar	4	6.110-048.0	140 bar					10 m flexible high-pressure hose (DN 6) for cleaning pipes (threaded connection for R 1/8 nozzle).	<input type="checkbox"/>
Pipe cleaning hose, ID 6, 20 m, max. 140 bar	5	6.110-049.0	140 bar					The 20 m pipe cleaning hose is a highly flexible high pressure hose for pipe interior cleaning (threaded connection for nozzle R 1/8).	<input type="checkbox"/>
Pipe cleaning hose, ID 6, 30 m, max. 140 bar	6	6.110-050.0	140 bar					30 m flexible high-pressure hose (DN 6) for cleaning pipes (threaded connection for R 1/8 nozzle).	<input type="checkbox"/>
Pipe cleaning nozzle									
Pipe cleaning dirt blaster D21/040	7	4.765-001.0		40	21 mm			The forward-tilted rotating pencil jet removes the most stubborn dirt. The three backwards-tilted jets ensure the necessary forward movement, as well as convenient handling.	<input type="checkbox"/>
Pipe cleaning dirt blaster D30/040	8	4.765-004.0		40	30 mm				<input type="checkbox"/>
Pipe cleaning nozzle	9	5.763-015.0		55	16 mm			16 mm pipe cleaning nozzle with internal thread. Various jet directions for environmentally-friendly cleaning of blocked drains and pipes.	<input type="checkbox"/>
	10	5.763-016.0		60	16 mm				<input type="checkbox"/>
	11	5.763-017.0		50	30 mm			Pipe cleaning nozzle with inner thread. Different spray directions. The hose moves freely through the pipe. (R 1/8" connection, 3 x 30° backwards, diameter 30 mm.)	<input type="checkbox"/>
Rotating pipe cleaning nozzle	12	6.415-428.0		50	16 mm			Pipe cleaning nozzle with four rotating jets and inner thread. Different spray directions. The hose moves freely through the pipe. With R 1/8" connection.	<input type="checkbox"/>

■ Included in the scope of supply. □ Available accessories. ▲ Extension hose.

HD 6/15 M 1.150-930.0

KÄRCHER



		Order no.	Flow rate	Nozzle size	Diame- ter	Price	Description	
Hard Surface Cleaner FRV 30								
Rubber lip for FRV 30	1	2.642-910.0					For smooth floors indoors. The squeegee increases the suction performance of the FRV 30 and minimises the amount of water remaining. This means the floor is dry in just a few minutes.	<input type="checkbox"/>
Extension hose 5 m	2	4.440-939.0					5m extension hose for FRV 30. Connection sleeve included.	<input type="checkbox"/>
Hose fastening attachment kit	3	2.642-528.0					Suction cup for fixing the suction hose to smooth surfaces.	<input type="checkbox"/>
Dirt trap attachment kit	4	2.642-532.0					Galvanised steel bucket for collecting coarse dirt and for fixing the suction hose in outside areas.	<input type="checkbox"/>
FRV 30 Surface Cleaner	5	2.111-010.0					With the integrated, automatic suction of the dirty water, the FRV 30 makes surface cleaning even more efficient and can be used in both inside and outside areas. There is no longer a need to rinse the surface after cleaning, since the dirty water can be discharged through the 5 m suction hose supplied. Additional quality features are the non-marking steering rollers and double ceramic bearing. Machine-specific nozzle kit must be ordered separately. Max. 250 bar / 1000 l/h / 60°C.	<input type="checkbox"/>
Hard surface cleaner FR 30								
FR 30 Surface Cleaner	6	2.111-011.0			300 mm		Up to 10 times greater area performance compared with the conventional high-pressure jet. Plastic casing for optimal manoeuvrability, double ceramic bearing for long working times, flexible connection joint for optimal handling and integrated parking position. Machine-specific nozzle kit must be ordered separately. Max. 180 bar / 850 l/h / 60°C.	<input type="checkbox"/>
FR 30 Me surface cleaner								
Hard Surface Cleaner FR 30 Me	7	2.111-013.0			300 mm		Hot water resistant stainless steel surface cleaner with double ceramic bearings, non-marking swivel castors and suction hose connection. Ideal for indoor cleaning, e.g. food industry.	<input type="checkbox"/>
Machine-specific nozzle kits for FR								
Nozzle kit for surface cleaners	8	2.640-401.0	500 - 650 l/h				Nozzle kit includes power nozzles and unions. For Kärcher surface cleaners (500 to 650 l/h).	<input type="checkbox"/>
Machine-specific nozzle kits for FRV								
Nozzle kit 035 - for FRV	9	2.642-430.0		35			Machine-specific nozzle kit with Kärcher power nozzles and jet nozzle for FRV 30.	<input type="checkbox"/>
FRV 30 Me surface cleaner								
Extension hose FRV 30 Me and FRV 50 Me	10	4.441-040.0					5 m extension hose for FRV 30 Me. Includes connecting adapter.	<input type="checkbox"/>
FRV 30 Me Surface Cleaner	11	2.111-012.0					Thanks to automatic suction of the dirty water, the stainless steel FRV 30 Me Surface Cleaner makes surface cleaning more efficient in both inside and outside areas. Hot water cleaning up to 85°C.	<input type="checkbox"/>

■ Included in the scope of supply. □ Available accessories. ▲ Extension hose.

HD 6/15 M 1.150-930.0

KÄRCHER



		Order no.	Flow rate				Price	Description	
Cup foam lance									
Cup foam lance Basic 1	1	4.112-053.0	350 - 600 l/h					For high-pressure cleaners with a flow rate of 350-600 l/h: new, robust and very high-quality Basic 1 cup foam lance with outstanding foam quality while consuming half as much cleaning agent.	<input type="checkbox"/>
Cup foam lance Advanced 042	2	2.112-018.0						Short, handy foam lance with adjustable spray angle with 1 litre detergent tank. Ideal for cleaning cars due to its compact design.	<input type="checkbox"/>
1-litre cleaning agent container for basic foam lance	3	5.071-414.0							<input type="checkbox"/>
1-litre cleaning agent container for advanced foam lance	4	6.414-050.0						Additional 1-litre cleaning agent container for quick replacement of the cleaning agent (for foam lance 2.112-017.0 and 2.112-018.0).	<input type="checkbox"/>
Inno Foam Kit									
Inno Foam Set with detergent injector	5	2.112-000.0						High-pressure foam system with double lance (foam nozzle and high-pressure jet for rinsing). For use with mobile and stationary high-pressure and HDS pressure cleaners for cleaning or disinfection.	<input type="checkbox"/>
Easy Foam Set									
Easy Foam Set with RM injector	6	2.112-010.0						HP foam system for use with HD/HDS units for cleaning and disinfecting. Foam nozzle for connection to lance and HP chemical injector with precision 0-5% metering valve. The machine specific nozzle kit has to be ordered separately.	<input type="checkbox"/>
Nozzle kits for Inno/Easy Foam Set									
Nozzle kit 055 for Inno / Easy Set 500-600 l/h	7	2.111-009.0	500 - 600 l/h					Optimal adaptation to different machine outputs for economic use.	<input type="checkbox"/>
Foam nozzle mounting kit									
Foam nozzle attachment kit	8	2.112-013.0						Foaming agent kit. The foam nozzle is ideal for use in sanitary areas and the food industry and wherever long application times are necessary.	<input type="checkbox"/>

■ Included in the scope of supply. □ Available accessories. ▲ Extension hose.

HD 6/15 M 1.150-930.0

KÄRCHER



		Order no.	Length				Price	Description	
Manual hose reel attachment kit									
Hose reel attachment kit for high-pressure middle class	1	2.110-024.0	15 m						<input type="checkbox"/>
Automatic, self-winding hose reels for wall mounting									
Wall-mounted hose reel	2	2.639-257.0	15 m						<input type="checkbox"/>
Automatic hose reel, powder-coated steel / plastic	3	6.392-074.0	20 m					Automatic hose reel for 20 m high-pressure hose. The console is made from powder-coated steel, the drum is made from plastic.	<input type="checkbox"/>
Automatic stainless steel / synthetic material hose drum	4	6.392-083.0	20 m					Automatic hose reel for 20 m high-pressure hose. The console consists of stainless steel, the drum is made from plastic.	<input type="checkbox"/>
Automatic hose reel, coated	5	6.392-106.0	20 m					Automatic hose reel of durable plastic. Painted steel bracket. Suitable for 20 m high-pressure hose.	<input type="checkbox"/>
Hose reel, automatic, basalt grey-coated	6	6.392-105.0	20 m					Automatic hose reels provide the highest level of safety and convenience for winding and unwinding HP hoses. For example: order no. 6.110-011.0 (ID 8, 20 m, 315 bar) or order no. 6.110-028.0 (ID 8, 20 m, 400 bar Longlife).	<input type="checkbox"/>
Automatic hose reel, stainless steel, includes swivel holder	7	6.392-076.0	20 m					Automatic stainless steel hose reel. With swivel holder. Suitable for 20 m high-pressure hose.	<input type="checkbox"/>
Automatic stainless steel hose reel	8	6.392-122.0	20 m					High-grade, automatic steel hose reel. Especially suitable for use in the food industry. The material and finish provide for a corrosion-resistant, watertight capsuled sprong drive. Connection for HP hoses with nipple.	<input type="checkbox"/>
	9	6.392-442.0	40 m					Automatic hose reels provide the highest level of safety and convenience for winding and unwinding HP hoses. Compatible high-pressure hose, e.g. order no. 6.110-076.0 (ID 8, 40 m, 400 bar, 1x hose reel connection attachment kit).	<input type="checkbox"/>
Powder-coated swivel holder	10	2.639-931.0						Swivel holder for automatic hose reel wall mounting. For maximum action radius and flexibility of high-pressure hose. Rotatable 120°. Galvanised steel.	<input type="checkbox"/>
Stainless steel swivel holder	11	2.641-867.0						Swivelling wall bracket made of high-grade steel (for 2.641-866). This makes maximum flexibility and convenience possible when working with the HP hose.	<input type="checkbox"/>

■ Included in the scope of supply. □ Available accessories. ▲ Extension hose.

HD 6/15 M

1.150-930.0

KÄRCHER



		Order no.	Flow rate	Inlet temperature	Length	Length	Price	Description	
Teleskopstangen									
iSolar TL 14 C (without hose)	1	4.110-002.0		max. 60 °C				Full carbon telescopic rod for maximum rigidity with minimal weight. With 14 m max. reach and practical quick-release couplings for easy extension and retraction.	<input type="checkbox"/>
iSolar TL 10 C (without hose)	2	4.110-007.0		max. 60 °C				The full carbon telescopic lance offers maximum rigidity with minimal weight. It has a reach of up to 10 m and is fitted with practical quick-release couplings - for convenient extension and retraction. The speed is regulated via ball tap, guaranteeing easy handling. For occupational safety reasons, the lowest lance element is made from a carbon-fibre-glass mixture for electrical insulation.	<input type="checkbox"/>
iSolar TL 10 H (without hose)	3	4.110-003.0		max. 60 °C				Telescopic rod made from a carbon/fibreglass mixture for maximum rigidity with minimum weight. With 10 m max. reach and practical quick-release couplings for easy extension and retraction.	<input type="checkbox"/>
iSolar TL 7 H (without hose)	4	4.110-004.0		max. 60 °C				Telescopic rod made from a carbon/fibreglass mixture for maximum rigidity with minimum weight. With 7.2 m max. reach and practical quick-release couplings for easy extension and retraction.	<input type="checkbox"/>
TL low pressure adapter	5	4.580-097.0		max. 40 °C				TL low-pressure adapter comprising ball valve for tool-free installation on telescopic lances. Ideal for applications with rotating high-pressure brushes.	<input type="checkbox"/>
Telescopic lance TL 7 F	6	4.762-609.0		max. 60 °C				Telescopic lance TL 7 F with up to 7 m reach made from robust and lightweight glass fibre. With practical quick-release fasteners for simple retraction and extension.	<input type="checkbox"/>
Telescopic lance TL 7 H	7	4.762-610.0		max. 60 °C				Multifunctional hybrid telescopic lance TL 7 H made of rigid and lightweight carbon-glass fibre mix. Telescopic thanks to quick-release fastenings. Up to 7 m reach.	<input type="checkbox"/>
Telescopic lance TL 10 H	8	4.762-611.0		max. 60 °C				Up to 10 m reach: hybrid telescopic lance TL 10 H. Comprising carbon-glass fibre mix and suitable for multifunctional use. Simple retraction and extension thanks to quick-release fasteners.	<input type="checkbox"/>
Telescopic lance TL 10 C	9	4.762-612.0		max. 60 °C				Carbon fibre telescopic lance TL 10 C. With up to 10 m reach and practical quick-release fasteners. Multifunctional use for cleaning facades, windows or solar panels.	<input type="checkbox"/>
Telescopic lance TL 14 C	10	4.762-613.0		max. 60 °C				Maximum rigidity with minimum weight: telescopic lance TL 14 C made from carbon fibre. Enormous reach of 14 m, multifunctional use and easy to use thanks to quick-release fasteners.	<input type="checkbox"/>
TL high pressure adapter	11	4.775-154.0		max. 60 °C				TL high-pressure adapter, flexible high-pressure gun for high-pressure cleaning with telescopic lances. Ergonomic, easy to install, suitable for right- and left-handed individuals.	<input type="checkbox"/>

■ Included in the scope of supply. □ Available accessories. ▲ Extension hose.

HD 6/15 M 1.150-930.0



		Order no.	Flow rate	Inlet temperature	Length	Length	Price	Description	
Schläuche									
iSolar HP hose 7	1	6.392-978.0		max. 155 °C				High-quality, flexible HP hose (with rubber covering) for the iSolar TL 7. The outer layer has especially good sliding properties when extending and retracting the telescopic rod.	<input type="checkbox"/>
iSolar HP hose 10	2	6.392-977.0		max. 155 °C				High-quality, flexible HP hose (with rubber covering) for the iSolar TL 10. The outer layer has especially good sliding properties when extending and retracting the telescopic rod.	<input type="checkbox"/>
iSolar HP hose 14	3	6.392-976.0		max. 155 °C				High-quality, flexible HP hose (with rubber covering) for the iSolar TL 14. The outer layer has especially good sliding properties when extending and retracting the telescopic rod.	<input type="checkbox"/>

■ Included in the scope of supply. □ Available accessories. ▲ Extension hose.

HD 6/15 M 1.150-930.0



		Order no.	Nozzle size				Price	Description	
Wet blasting attachment (without nozzle)									
Wet blasting attachment with flow control (without nozzles)	1	4.115-000.0						Paint, rust and scale removal made easy: Kärcher wet blasting attachment with flow control for adding blasting abrasive to the high-pressure jet.	<input type="checkbox"/>
Wet blasting attachment without flow control (nozzles not included)	2	4.115-006.0						Paint, rust and scale removal made easy: Kärcher wet blasting attachment with flow control for adding blasting abrasive to the high-pressure jet. Without flow control.	<input type="checkbox"/>
Nozzle kits for wet jet unit									
Nozzle kit for wet jet unit 035	3	2.112-021.0	35					Nozzle kit with wet blasting nozzle and nozzle insert (type specific). For optimal Kärcher wet blasting attachment performance. Only in combination with wet blasting attachment 4.115-000.0 4.115-006.0.	<input type="checkbox"/>
Boron carbide nozzle									
Boron carbide nozzle, for machines up to 1,000 l/h	4	6.415-084.0	6 mm					In addition to nozzle packs. Very wear-resistant nozzle with boron carbide chuck for continuous-duty operation.	<input type="checkbox"/>

■ Included in the scope of supply. □ Available accessories. ▲ Extension hose.

HD 6/15 M 1.150-930.0

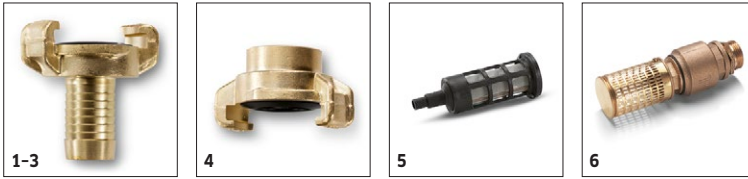

		Order no.			Price	Description	
Geka coupling							
Geka connector with hose barb, R 1/2"	1	6.388-461.0				with hose liner	<input type="checkbox"/>
Geka connector with hose barb, R 3/4"	2	6.388-455.0				with hose liner	<input type="checkbox"/>
Geka connector with hose barb, R 1"	3	6.388-465.0				with hose barb	<input type="checkbox"/>
Geka connector with inner thread, R 3/4"	4	6.388-473.0				with female thread	<input type="checkbox"/>
Suction filter							
Water suction filter	5	6.414-956.0				Suitable for ponds, storage tanks or similar, polyamide filter casing, stainless steel strainer, 800 µm mesh, R 3/4" and R 1" connection, without non-return valve	<input type="checkbox"/>
Suction filter with check valve	6	4.730-012.0				Brass suction filter suitable for ponds, storage tanks, etc. With check valve.	<input type="checkbox"/>

■ Included in the scope of supply. □ Available accessories. ▲ Extension hose.

HD 6/15 M

1.150-930.0



		Order no.			Price	Description	
Water fine filter							
Water fine filter, 100 µm, R 3/4"	7	2.637-691.0				Fine-mesh water filter, 100 µm, max. temperature 60°C. Protects the	<input type="checkbox"/>
Water fine filter, with adapter	8	4.730-102.0				Fine-mesh water filter, 125 µm, max. temperature 50°C. Protects the	<input type="checkbox"/>
Backflow check valve							
Backflow preventer	9	2.641-374.0				To prevent detergent getting into the drinking water cycle in case of inlet at	<input type="checkbox"/>
Other HP Accessories							
Starting current limiter	10	2.637-495.0				Reduces starting current in single-phase supply and protects line fuse.	<input type="checkbox"/>

■ Included in the scope of supply. □ Available accessories. ▲ Extension hose.

HD 6/15 M

1.150-930.0



		Order no.	Flow rate				Price	Description	
Push-on washing brush									
Push-on wash brush	1	4.113-001.0						For general-purpose cleaning of all surfaces. Clamps directly onto the spray lance. Connection M 18 x 1.5	<input type="checkbox"/>
Rotating washing brush									
Rotating wash brush for < 800 l/h machines, nylon bristles	2	4.113-004.0	500 - 800 l/h					The rotating wash brush gently removes fine dust and traffic film from all surfaces. Temperature resistant up to 60°C. (M 18 x 1.5, replaceable brush insert).	<input type="checkbox"/>
Rotating wash brush for < 800 l/h machines, natural bristles	3	4.113-003.0	500 - 800 l/h					Driven by water stream. Gently removes fine dust and traffic film from any surface. Temperature resistant up to 60°C, M 18 x 1.5 (replaceable brush insert).	<input type="checkbox"/>
Rotating wash brush for > 800 l/h machines, natural bristles	4	4.113-005.0	800 - 1300 l/h						<input type="checkbox"/>

■ Included in the scope of supply. □ Available accessories. ▲ Extension hose.